

FICHE DE L'EXPÉRIENCE N° 1 :

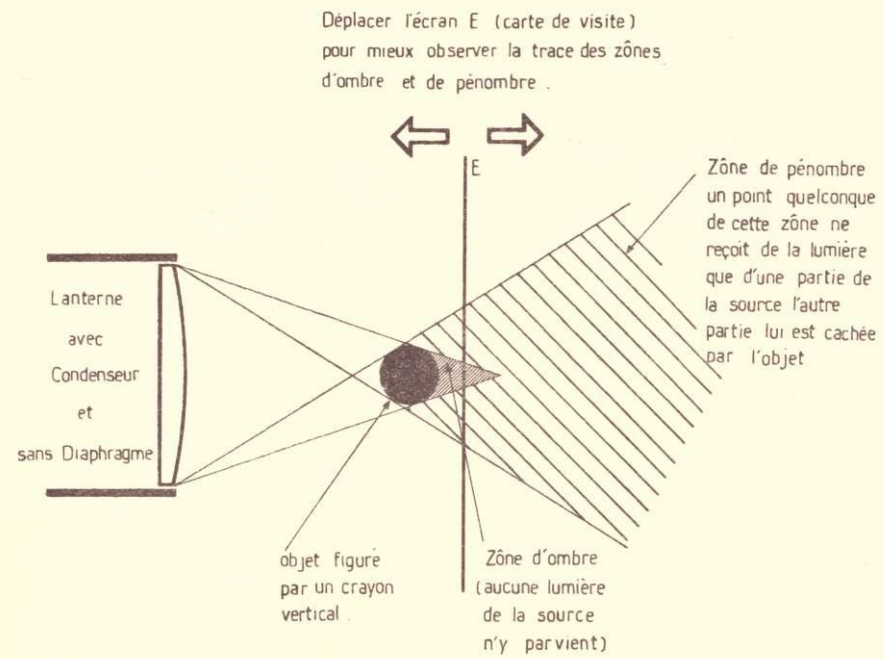

FICHE DE L'EXPÉRIENCE N° 2 :

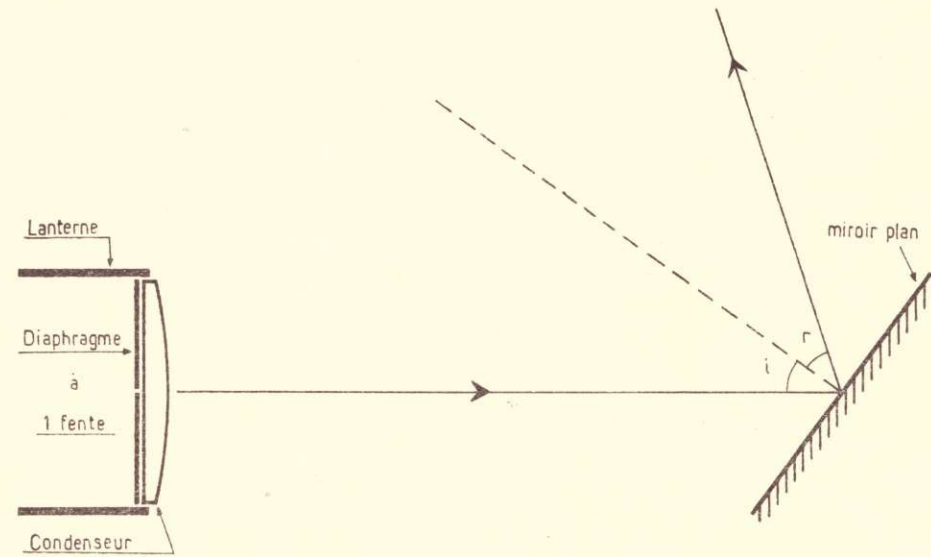

FICHE DE L'EXPÉRIENCE N° 3 :

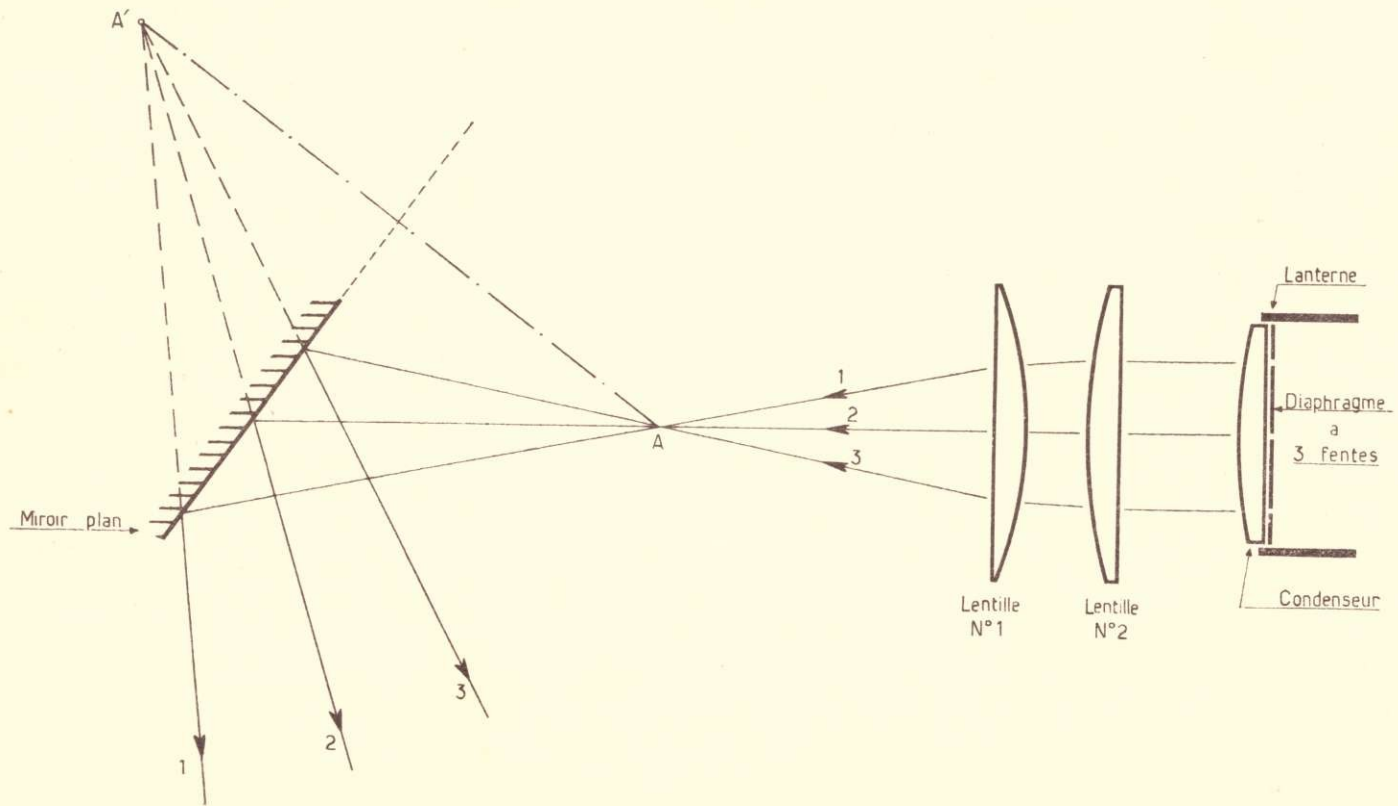

FICHE DE L'EXPÉRIENCE N° 4 :

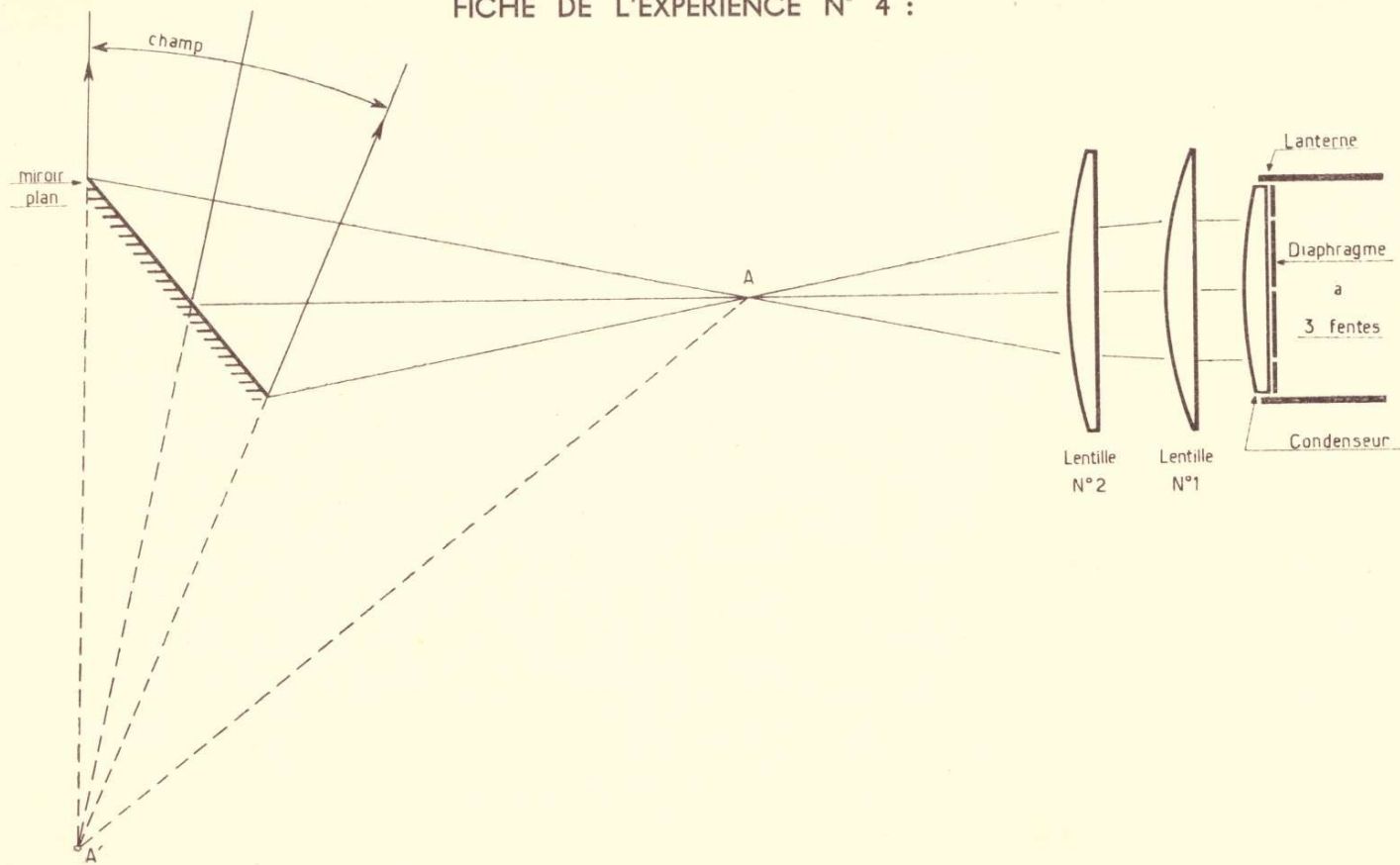

FICHE DE L'EXPÉRIENCE N° 8 :

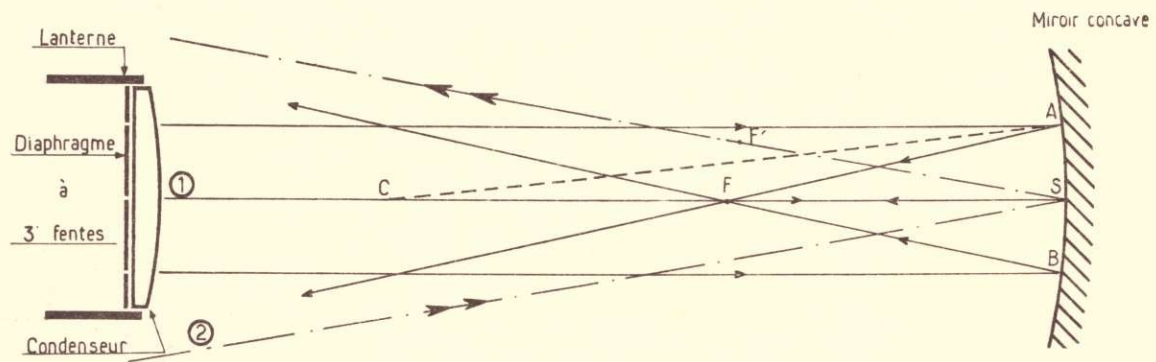

FICHE DE L'EXPÉRIENCE N° 9 :

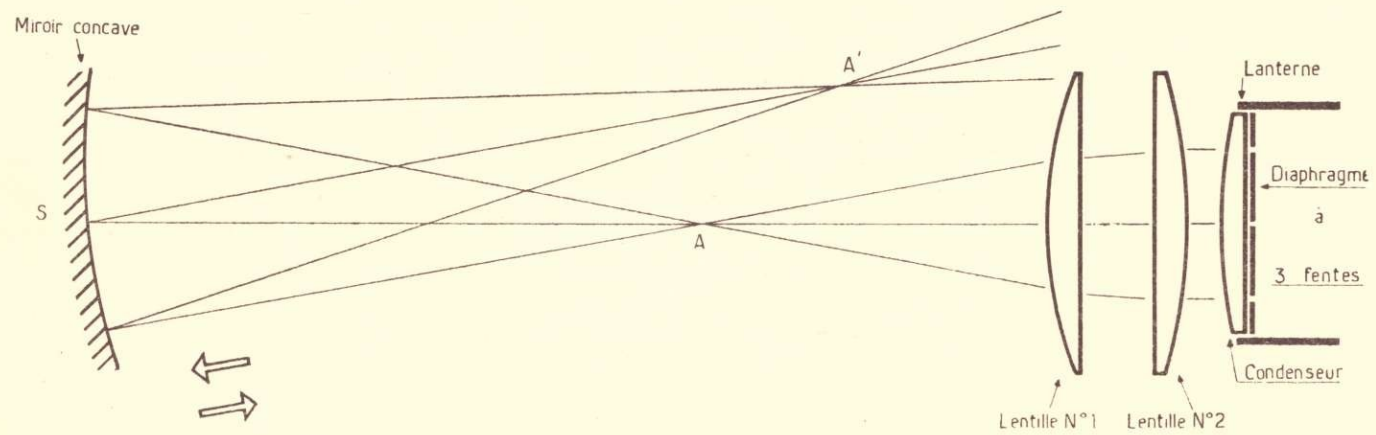

FICHE DE L'EXPÉRIENCE N° 11 :

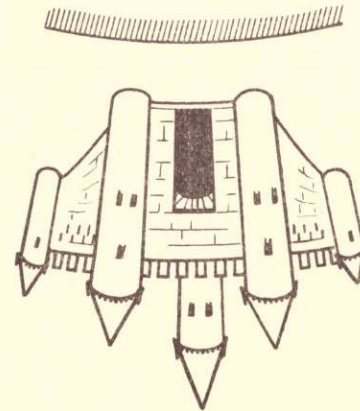
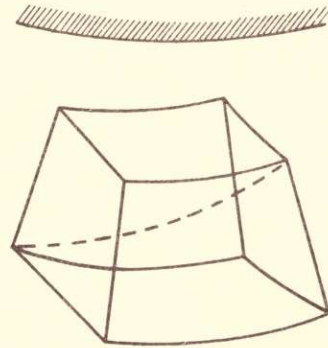
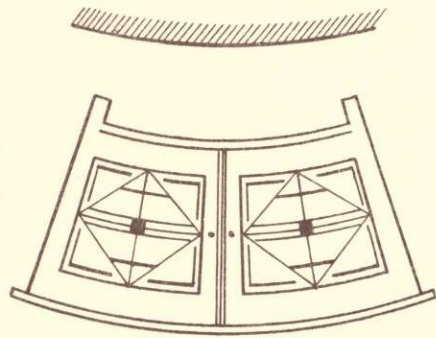

FICHE DE L'EXPÉRIENCE N° 10 :

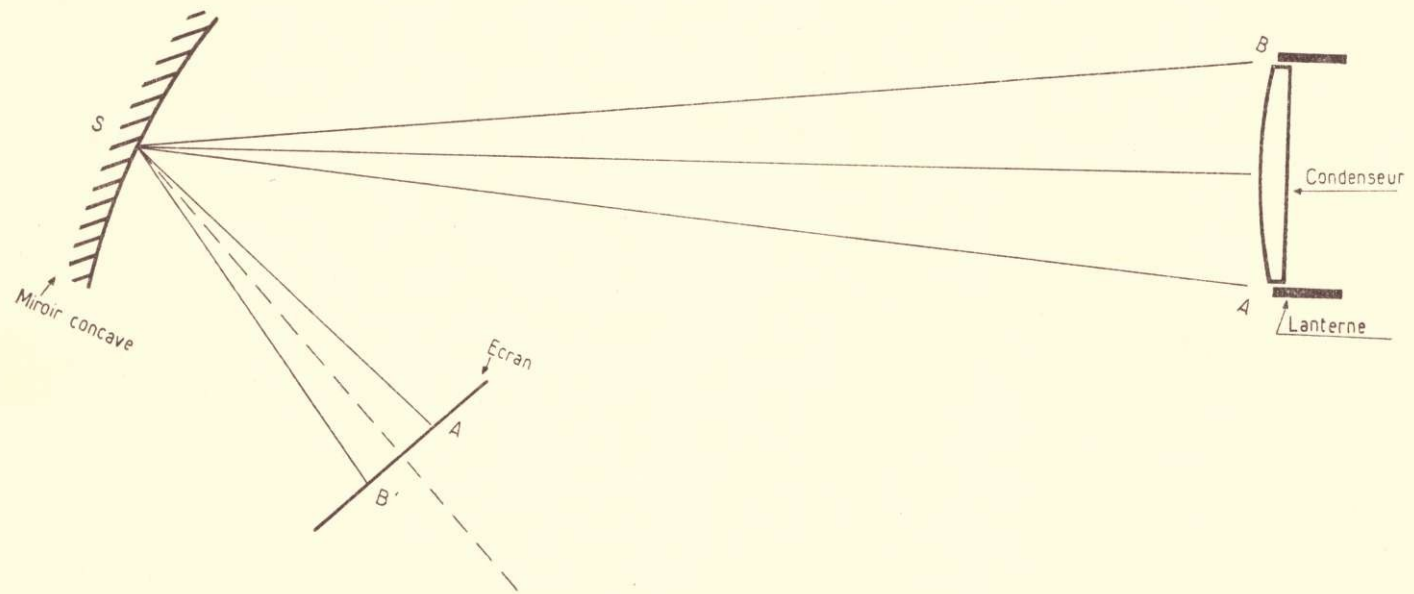

FICHE DE L'EXPÉRIENCE N° 12 :

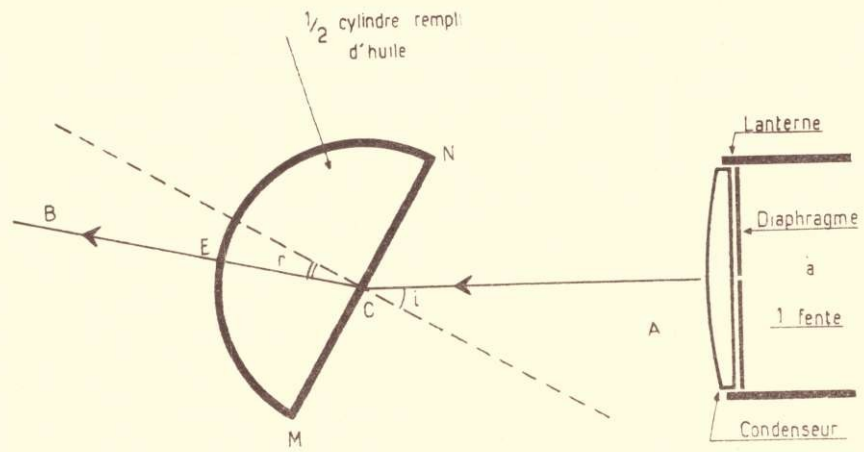

FICHE DE L'EXPÉRIENCE N° 14 :

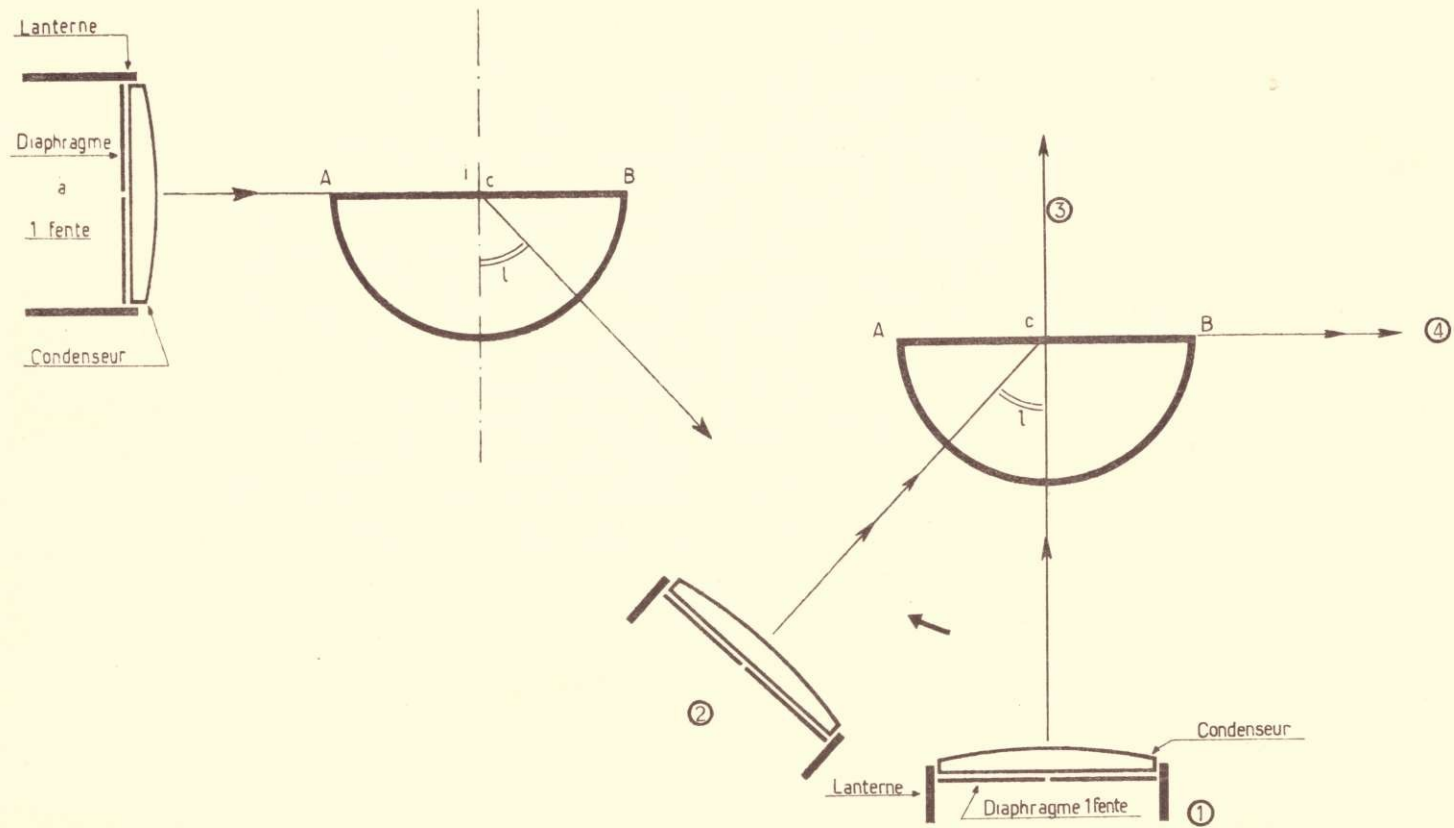

FICHE DE L'EXPÉRIENCE N° 18 :

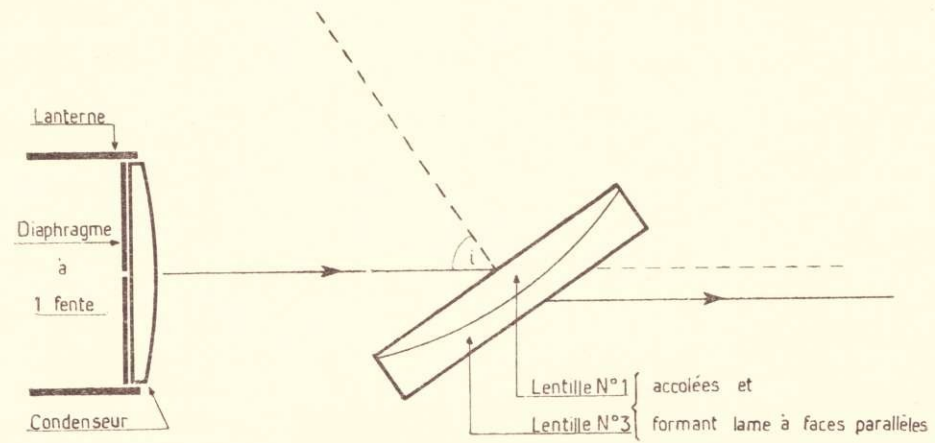

FICHE DE L'EXPÉRIENCE N° 19 :

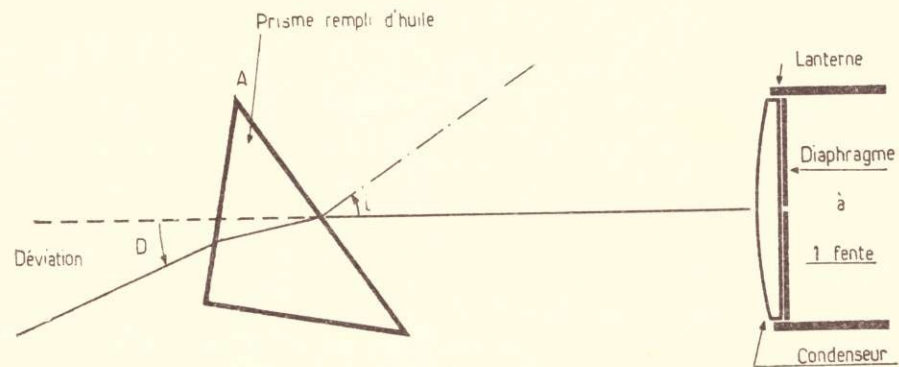

i	D

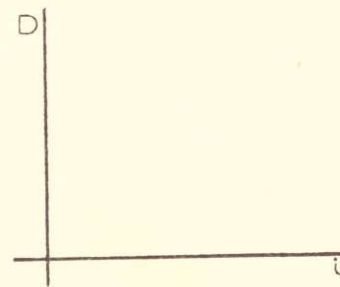

FICHE DE L'EXPÉRIENCE N° 20 :

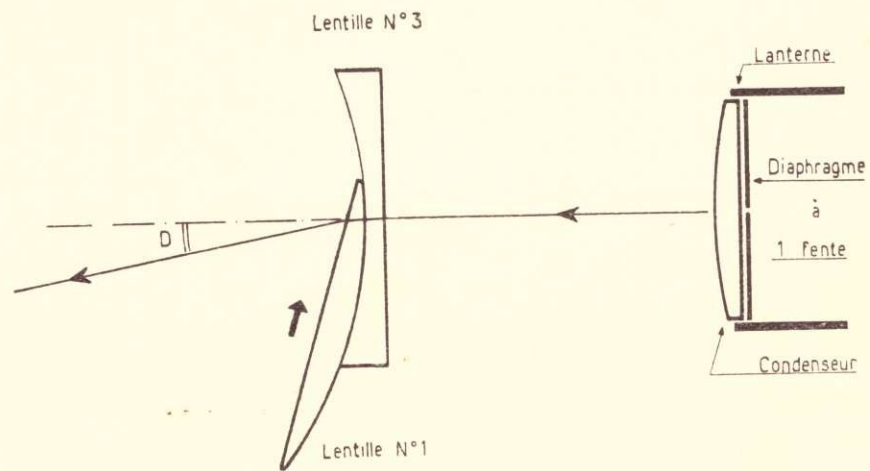

FICHE DE L'EXPÉRIENCE N° 21 :

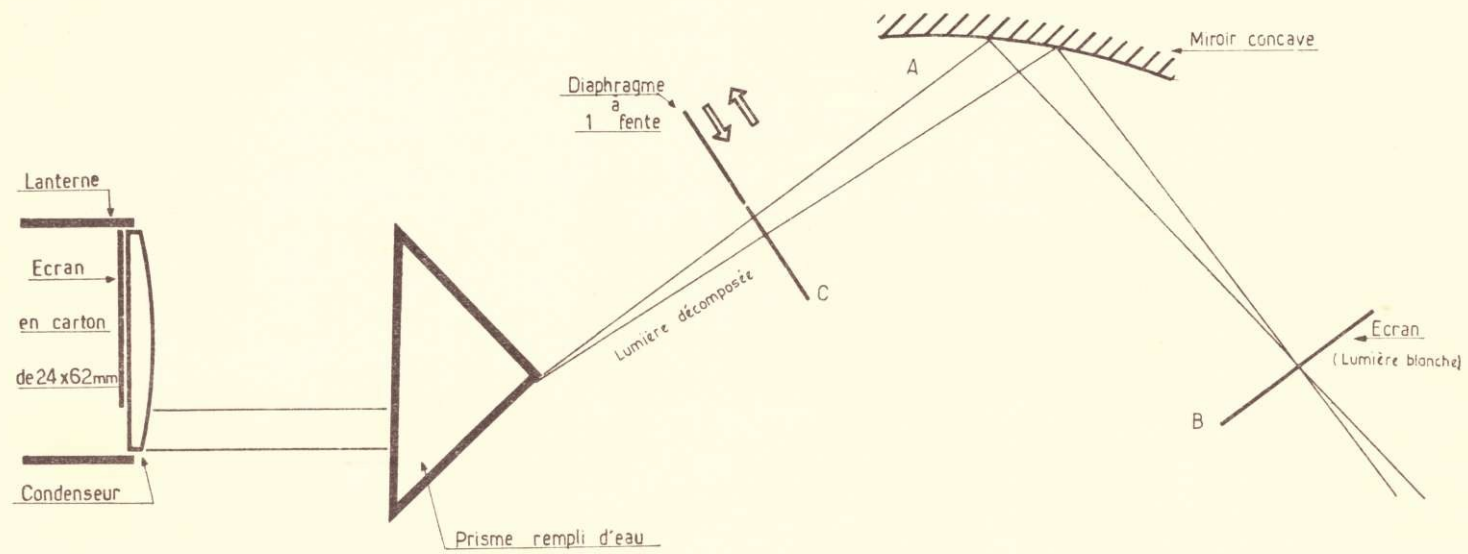

FICHE DE L'EXPÉRIENCE N° 22 :

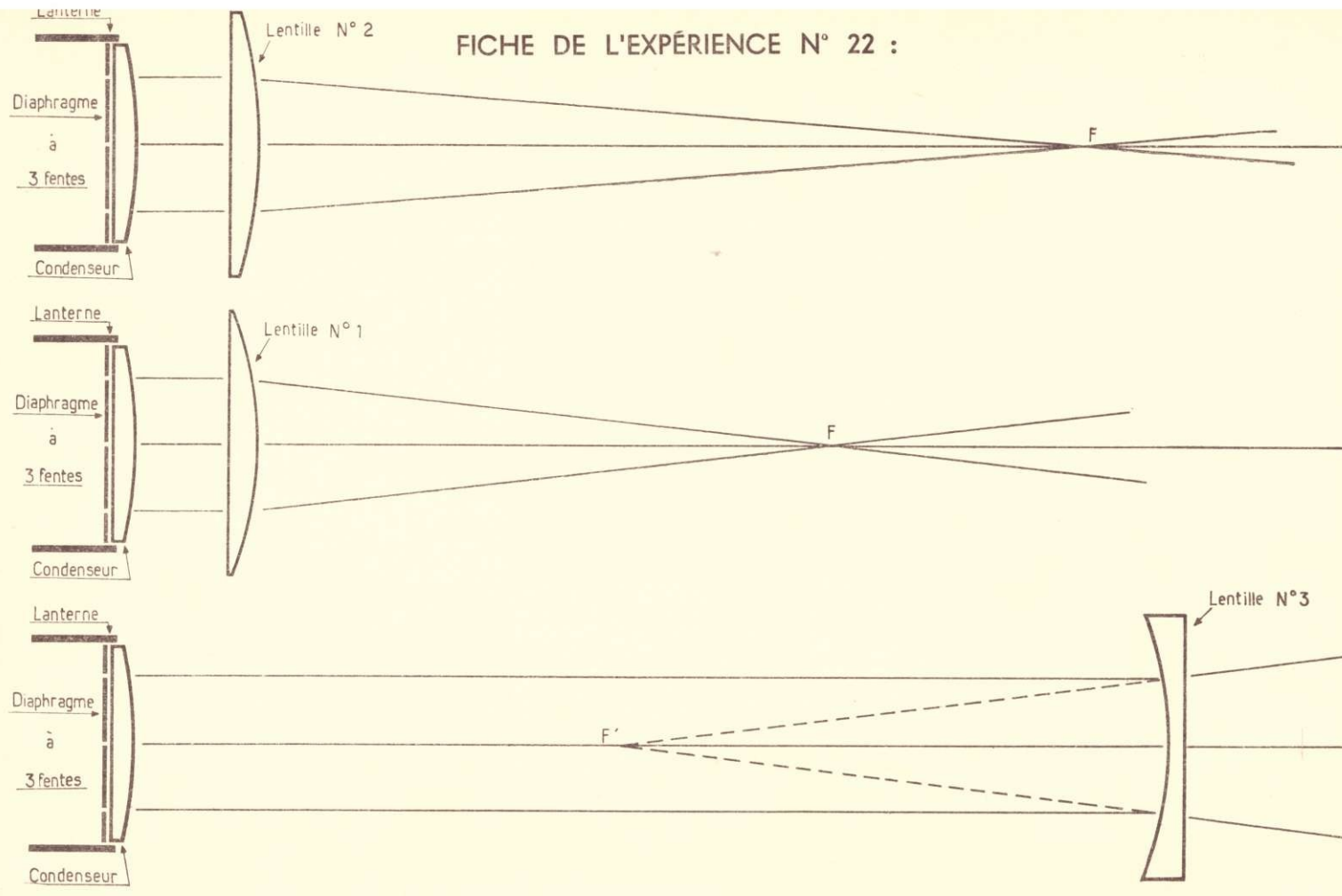

FICHE DE L'EXPÉRIENCE N° 23 :

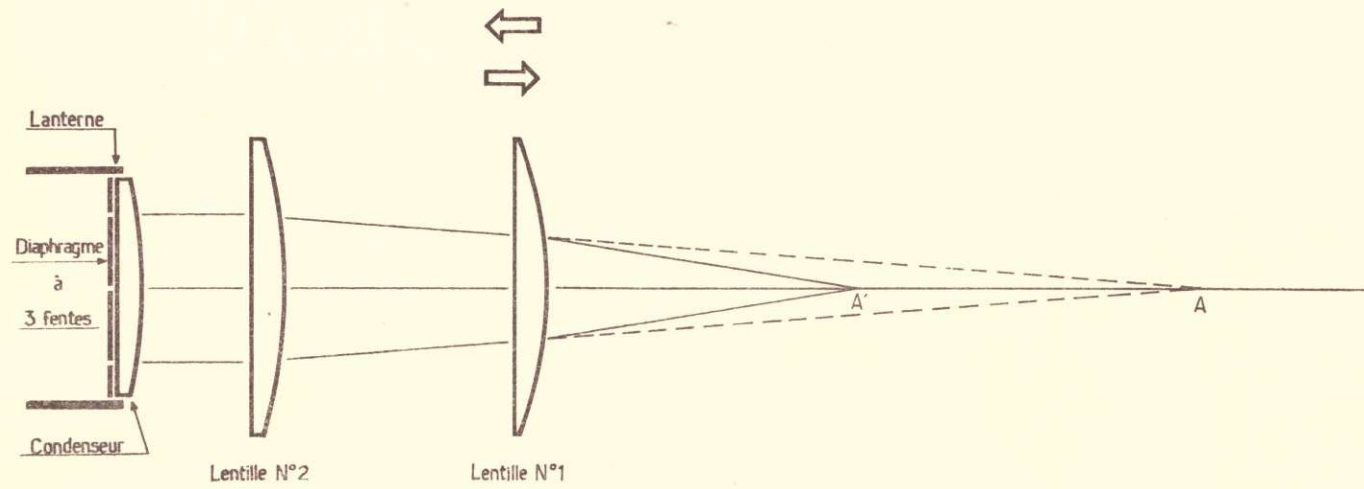

FICHE DE L'EXPÉRIENCE N° 27 :

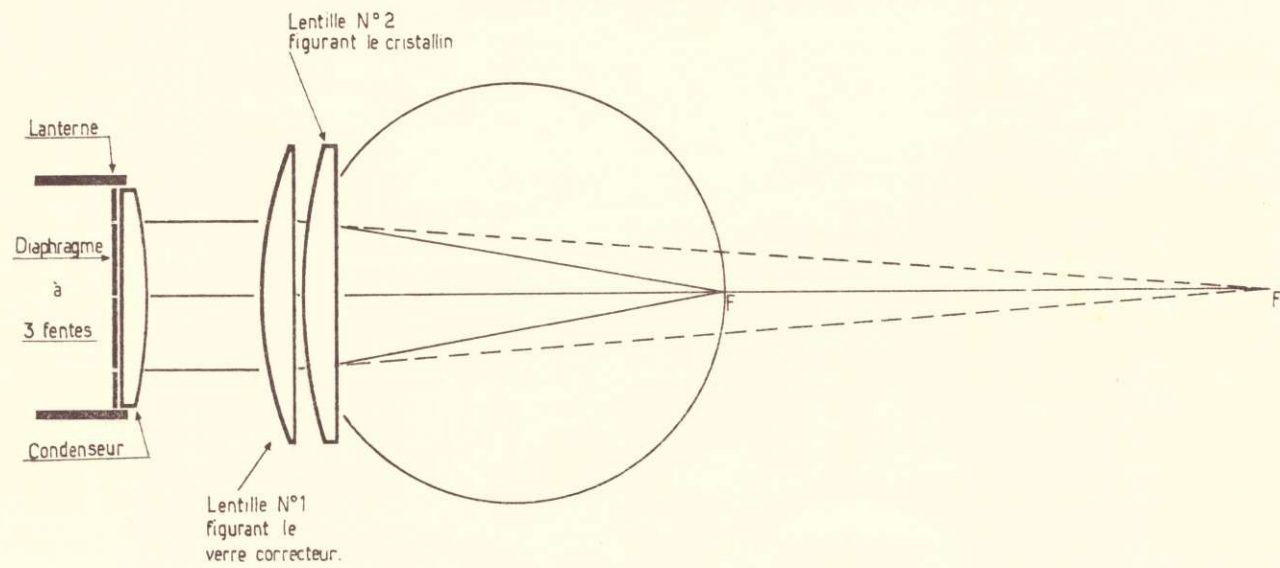

FICHE DE L'EXPÉRIENCE N° 28 :

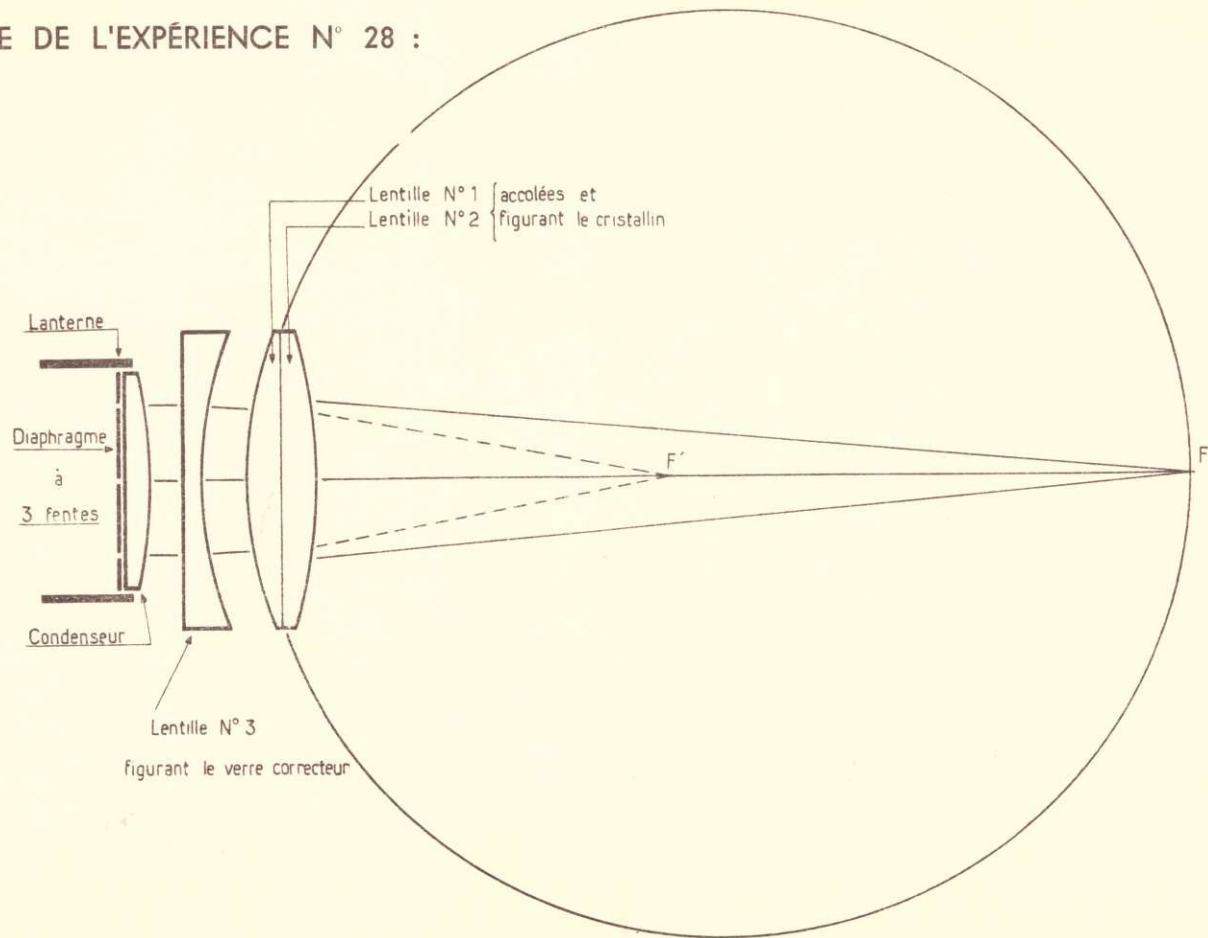

FICHE DE L'EXPÉRIENCE N° 31 :

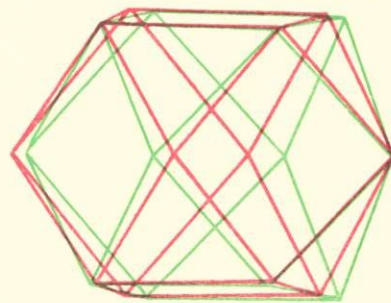

TABLE DES LIGNES TRIGONOMETRIQUES
NATURELLES

DEGRES.	RAD.	SIN.	TANG.	COT.	COS.	RAD.	DEGRES.
0	0,0000	0,0000	0,0000	∞	1,0000	1,5708	90
1	0,0175	0,0175	0,0175	57,29	0,9998	1,5533	89
2	0,0349	0,0349	0,0349	28,64	0,9994	1,5359	88
3	0,0524	0,0523	0,0524	19,08	0,9986	1,5184	87
4	0,0698	0,0698	0,0699	14,30	0,9976	1,5010	86
5	0,0873	0,0872	0,0875	11,43	0,9962	1,4835	85
6	0,1047	0,1045	0,1051	9,514	0,9945	1,4661	84
7	0,1222	0,1219	0,1228	8,144	0,9925	1,4486	83
8	0,1396	0,1392	0,1405	7,115	0,9903	1,4312	82
9	0,1571	0,1564	0,1584	6,314	0,9877	1,4137	81
10	0,1745	0,1736	0,1763	5,671	0,9848	1,3963	80
11	0,1920	0,1908	0,1944	5,145	0,9816	1,3788	79
12	0,2094	0,2079	0,2126	4,705	0,9781	1,3614	78
13	0,2269	0,2250	0,2309	4,331	0,9744	1,3439	77
14	0,2443	0,2415	0,2493	4,011	0,9703	1,3265	76
15	0,2618	0,2588	0,2679	3,732	0,9659	1,3090	75
16	0,2793	0,2756	0,2867	3,487	0,9613	1,2915	74
17	0,2967	0,2924	0,3057	3,271	0,9563	1,2741	73
18	0,3142	0,3090	0,3249	3,078	0,9511	1,2566	72
19	0,3316	0,3256	0,3443	2,904	0,9455	1,2392	71
20	0,3491	0,3420	0,3640	2,747	0,9397	1,2217	70
21	0,3665	0,3584	0,3839	2,605	0,9336	1,2043	69
22	0,3840	0,3746	0,4040	2,475	0,9272	1,1868	68
23	0,4014	0,3907	0,4245	2,356	0,9205	1,1694	67
24	0,4189	0,4067	0,4452	2,246	0,9135	1,1519	66
25	0,4363	0,4226	0,4663	2,145	0,9063	1,1345	65
26	0,4538	0,4384	0,4877	2,050	0,8988	1,1170	64
27	0,4712	0,4540	0,5095	1,963	0,8910	1,0996	63
28	0,4887	0,4695	0,5317	1,881	0,8829	1,0821	62
29	0,5061	0,4848	0,5543	1,804	0,8746	1,0647	61
30	0,5236	0,5000	0,5774	1,732	0,8660	1,0472	60
31	0,5411	0,5150	0,6009	1,664	0,8572	1,0297	59
32	0,5585	0,5299	0,6249	1,600	0,8480	1,0123	58
33	0,5760	0,5446	0,6494	1,540	0,8387	0,9948	57
34	0,5934	0,5592	0,6745	1,483	0,8290	0,9774	56
35	0,6109	0,5736	0,7002	1,428	0,8192	0,9599	55
36	0,6283	0,5878	0,7265	1,376	0,8090	0,9425	54
37	0,6458	0,6018	0,7536	1,327	0,7986	0,9250	53
38	0,6632	0,6157	0,7813	1,280	0,7880	0,9076	52
39	0,6807	0,6293	0,8098	1,235	0,7771	0,8901	51
40	0,6981	0,6428	0,8391	1,192	0,7660	0,8727	50
41	0,7156	0,6561	0,8693	1,150	0,7547	0,8552	49
42	0,7330	0,6691	0,9004	1,111	0,7431	0,8378	48
43	0,7505	0,6820	0,9325	1,072	0,7314	0,8303	47
44	0,7679	0,6947	0,9657	1,036	0,7193	0,8029	46
45	0,7854	0,7071	1,0000	1,000	0,7071	0,7854	45

